

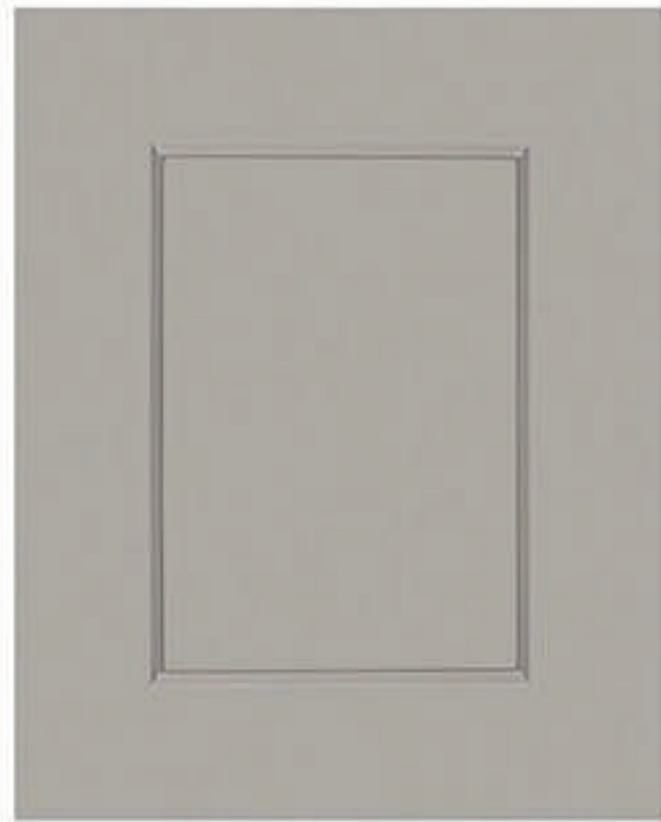



© WHITE SHAKER



© LIGHT GREY SHAKER



© GREY SHAKER

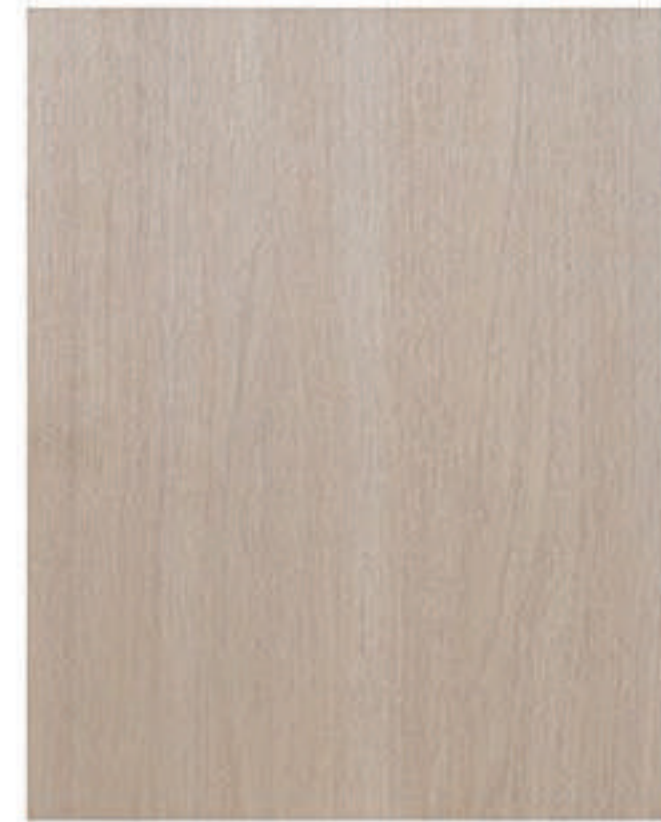

© COSMO SAND



© ARIA GREY



© DELANO GREY



© MAPLE SHAKER



© ESPRESSO SHAKER



© MATTE BLACK SHAKER



© OXFORD WHITE

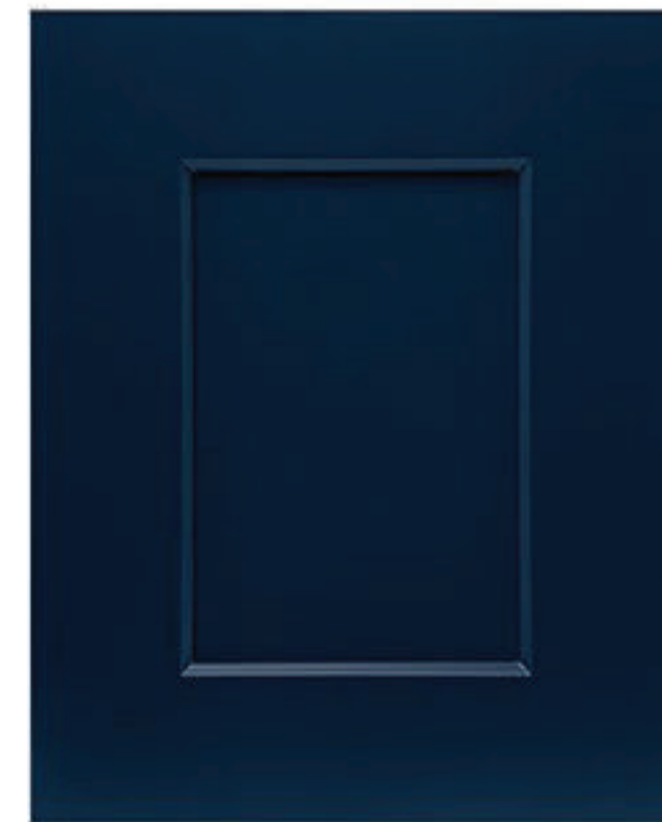

© ROYAL BLUE

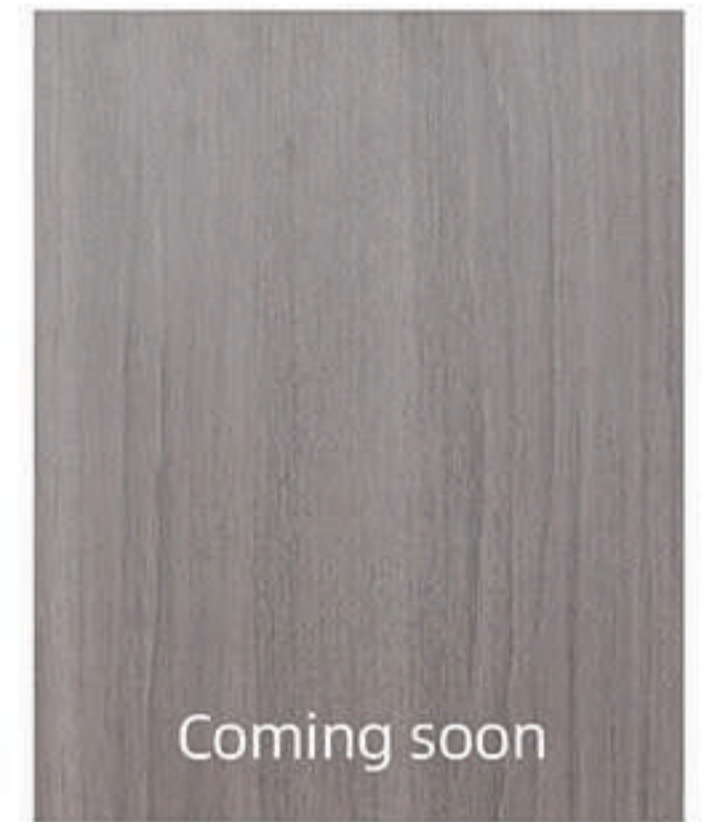

© SMOKE OAK



© ANTIQUE WHITE



© MAPLE WALNUT

MORE COLORS & STYLE AVAILABLE FOR PROJECTS AND OEM INQUIRIES SEE PAGE 37-38





What is an American Style (Framed) Cabinet?

What is an American Style (Framed) Cabinet?
 American cabinet manufacturers have traditionally built cabinets using a framed construction. In this type of cabinet construction, the rails and stiles form a 3/4 inch face "frame" at the front of the cabinet box. This frame resembles a flat picture frame attached to the door front, adding dimension to the door front. The cabinet doors are secured to the edge of the frame, which gives the cabinet strength and sturdiness.

American Style cabinets are made of solid wood doors face frames, and drawer faces with plywood construction cabinet boxes. The wood-dominant feel of the cabinets will bring your kitchen an elegant and timeless effect. To increase storage space efficiency, Our face-framed cabinet does not come with a center stile, allowing easier accessibility than other face-framed cabinets in the industry. Face framed cabinets offer both traditional and contemporary designs.

FRAMED CABINETS

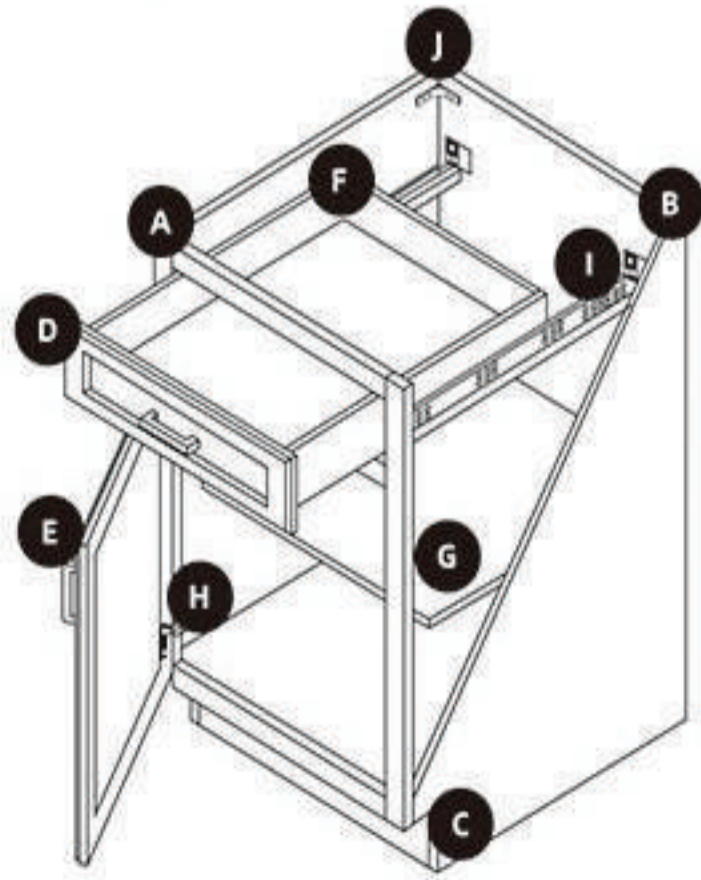

- A. 3/4" solid wood faceframe
- B. 1/2" high grade plywood box with matching interior finish
- C. 4 1/2" plywood toe kick
- D. Solid wood + MDF core drawer panel
- E. Solid wood + MDF core door panel
- F. 5/8" rubberwood dovetailed drawer box
- G. Adjustable 3/4" plywood shelf
- H. Adjustable soft-close concealed hinge
- I. Undermounted soft-close drawer slides
- J. Reinforced Metal Corner Bracer



Solid wood doors & drawers Dovetailed wood drawer box Plywood box construction 3/4" solid wood faceframe



Matching color interior Soft-close door hinge Soft-close drawer slide CARB2 & TSCA Compliant



FRAMED CABINETS

WHITE SHAKER
(WS)





FRAMED CABINETS

MATTE BLACK SHAKER
(MBS)

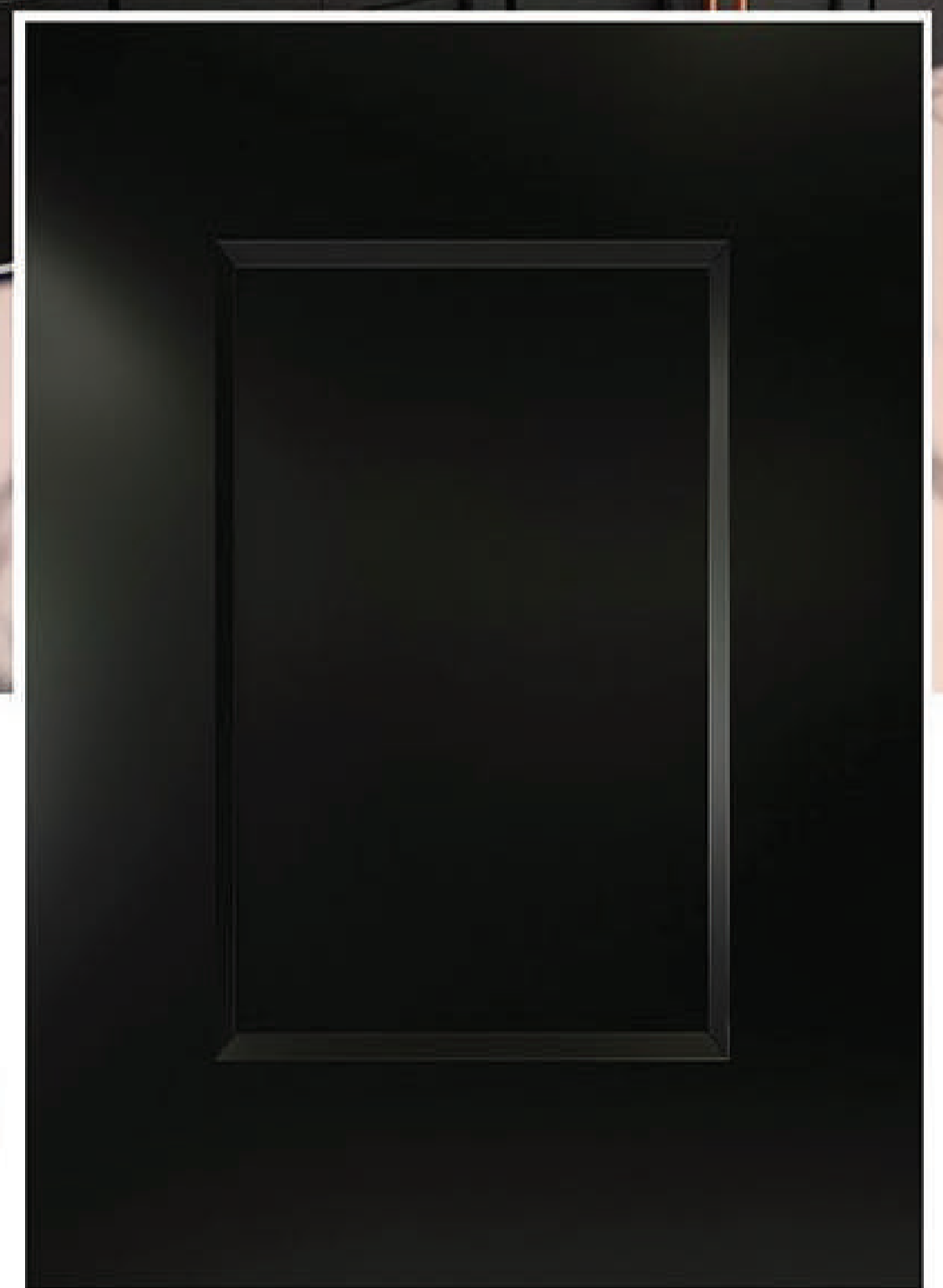



FRAMED CABINETS

LIGHT GREY SHAKER
(LGS)



FRAMED CABINETS

GREY SHAKER
(GS)





MAPLE SHAKER
(MS)

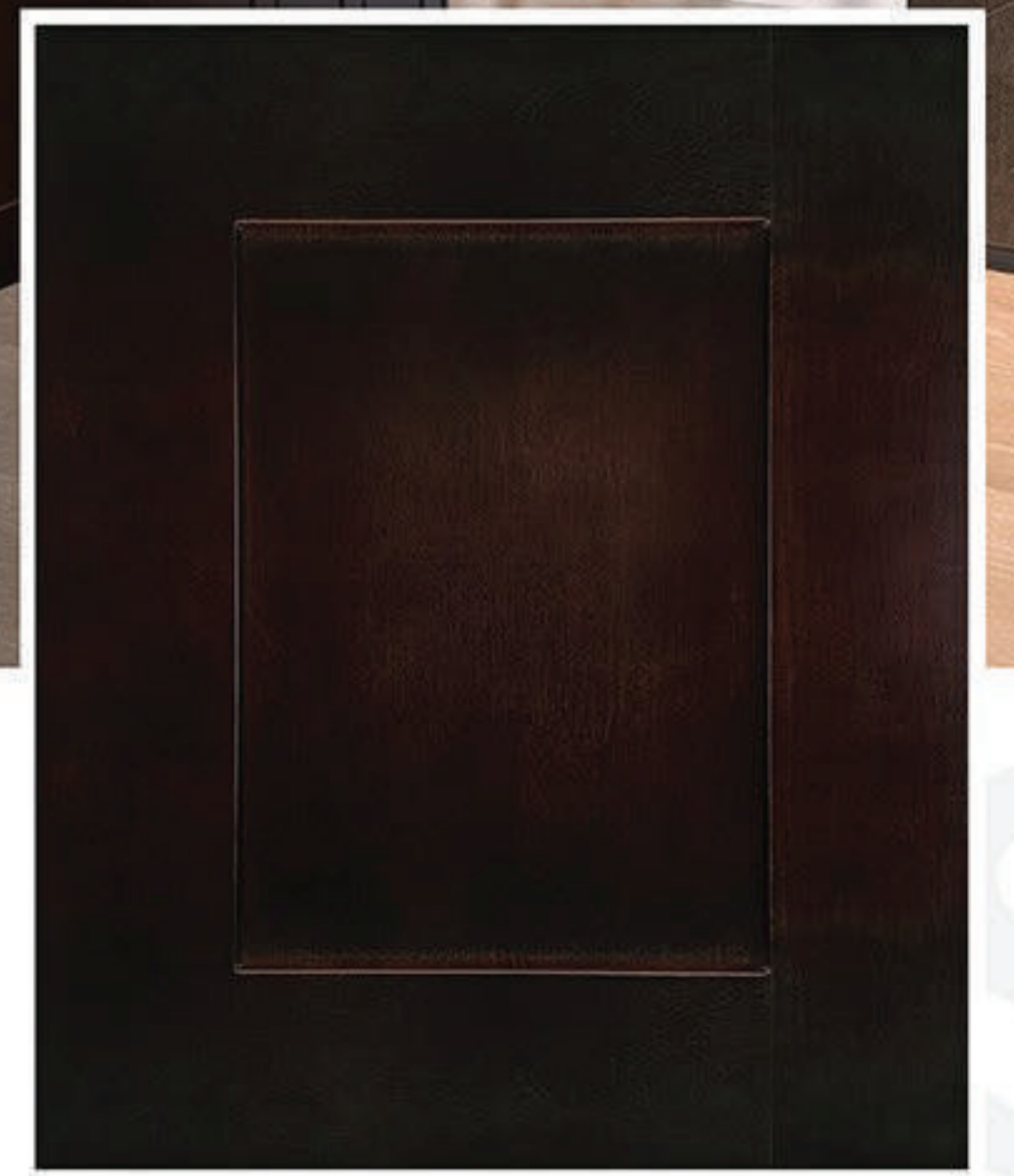

ESPRESSO SHAKER
(ES)

FRAMED CAB



ANTIQUÉ WHITE
(AW)



MAPLE WALNUT
(MW)

FRAMED CABINETS



What is a European Style (Frameless) Cabinet?

Frameless cabinet construction is a European way of manufacturing cabinets that has become popular among customers seeking simple and more contemporary cabinet designs. Frameless cabinetry is sometimes called "full access cabinet" because it offers greater accessibility by eliminating the face frame. Instead, it relies on thicker box construction for stability. Only full overlay doors can be used, with hinges attached directly to the sides of the cabinet box.

Our European Style line of cabinets offers flat panel door styles with a variety of color selections from solid gloss colors to textured wood grain colors. We use high-quality 3/4" thick solid plywood for cabinet box construction to ensure maximum durability. European Style is great for achieving a more modern, simple yet high-end look in your kitchen and bathrooms.

FRAMELESS CABINETS

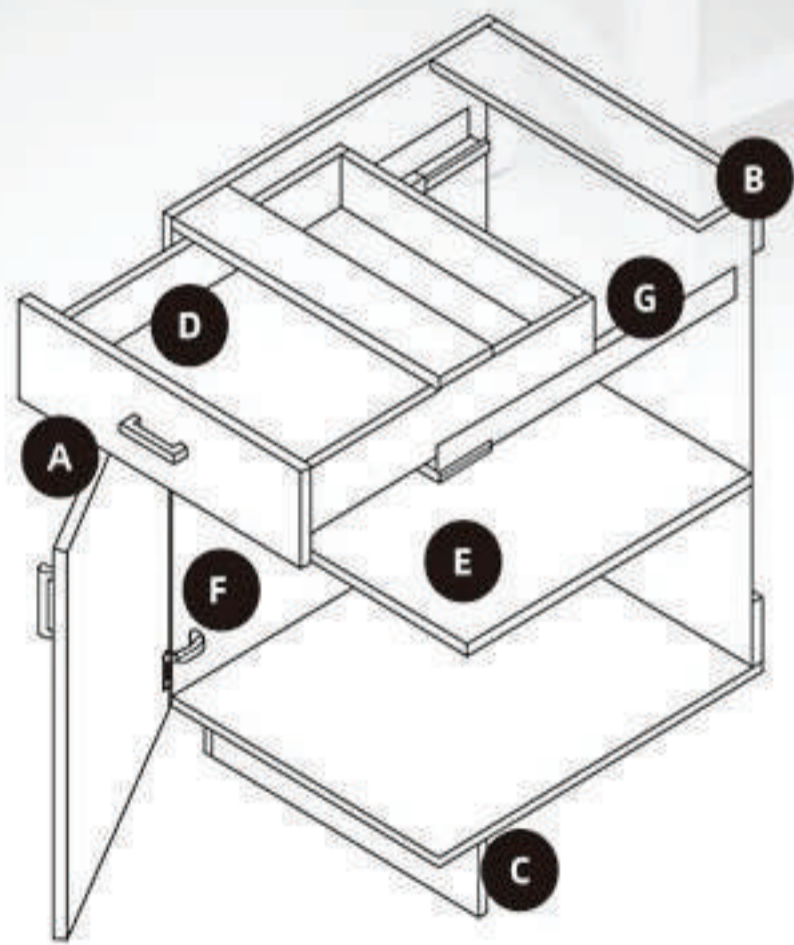

- A. Solid wood/ MDF and high-grade thermofoil Full Overlay Door and Drawer Panel
- B. Frameless 3/4" Solid plywood construction
- C. 4 1/2" High Toe Kick Panel
- D. Premium aluminum soft close drawer box
- E. 3/4 Solid plywood laminated in white with adjustable pegs
- F. Adjustable DTC style soft-close concealed hinges
- G. Soft-close undermount drawer glide



3/4" plywood construction box

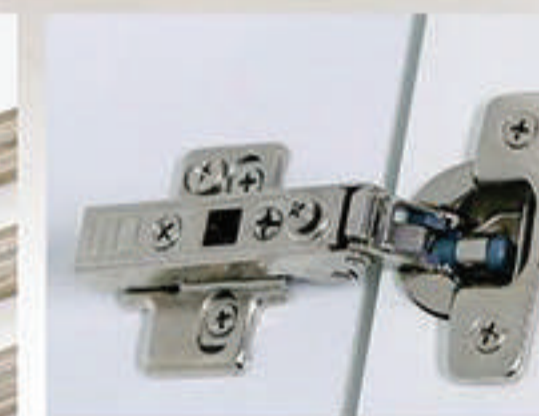

Soft close door

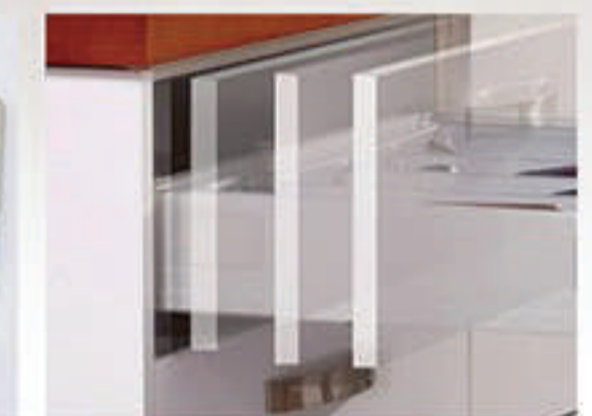

Soft close drawers

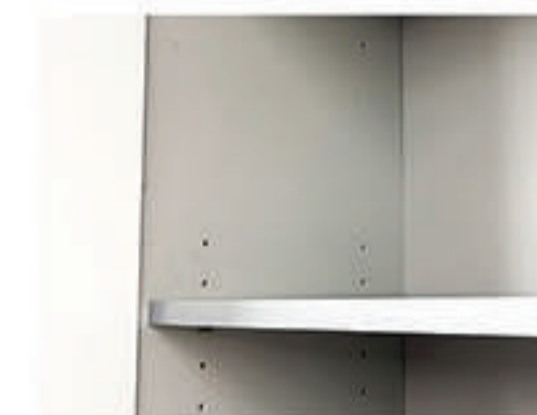

3/4" plywood adjustable shelf



White interior finish



CARB 2 /TSCA Certified



COSMO SAND
(CS)

SMOKE OAK
(SO)

FRAMELESS CABINETS



ARIA GREY
(AG)



DELANO GREY
(DG)

FRAMELESS CABINETS

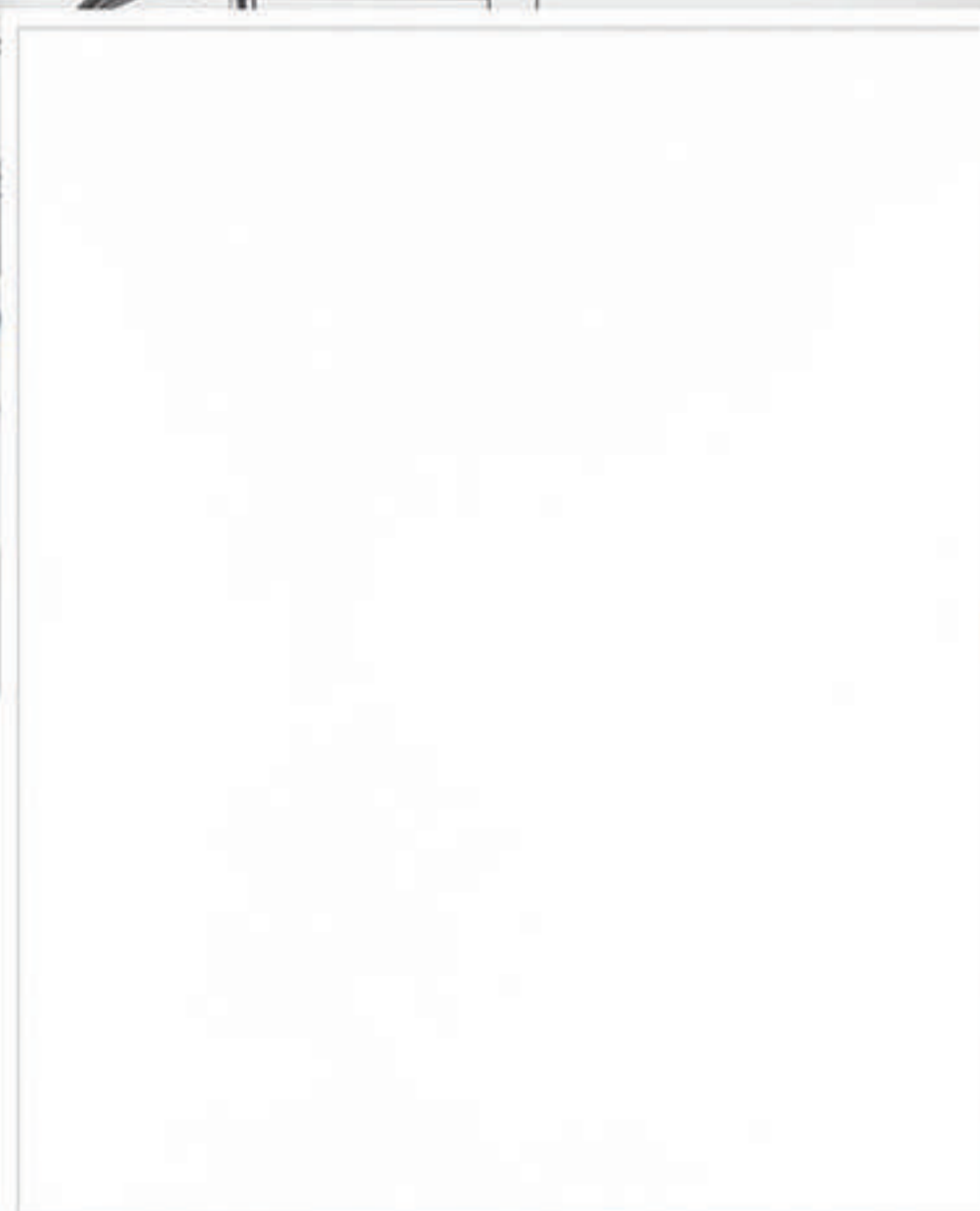

OXFORD WHITE
(OW)

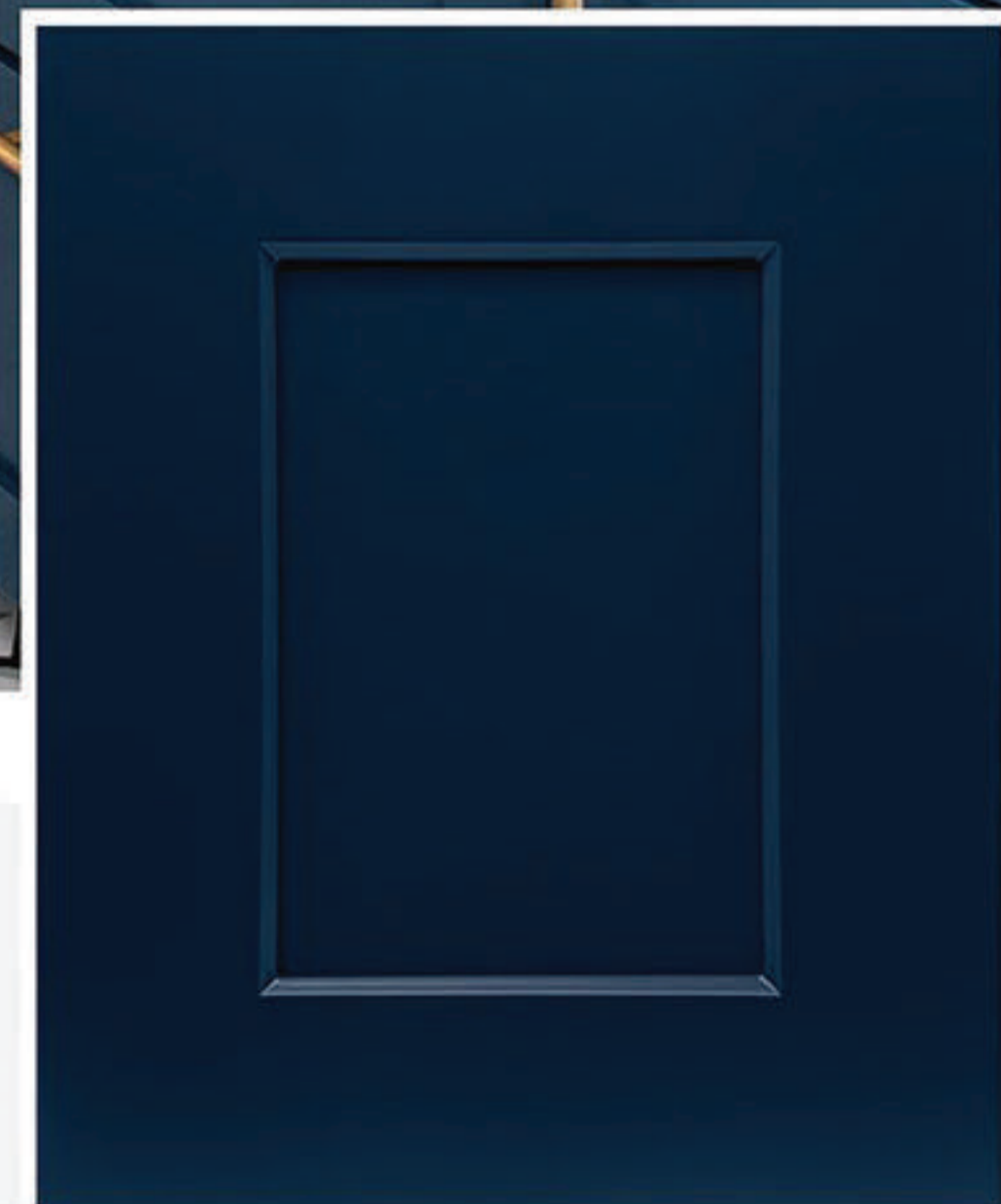

ROYAL BLUE
(RB)

FRAMELESS CABINETS

Model	Framed Cabinets								Frameless Cabinets			
	MBS	ES	MS	WS	MW	AW	GS	LGS	OW	AG	DG	RB
TALL DOUBLE DOOR PANTRY BASE & TOP (Width x 24" D x 84/90/94"H)												
PC2454B	✓	✓	✓	✓	✓	✓	✓	✓	✓	✓	✓	✓
PC2430T	✓	✓	✓	✓	✓	✓	✓	✓	✓	✓	✓	✓
PC2436T	✓	✓	✓	✓	✓	✓	✓	✓	✓	✓	✓	✓
PC2440T	✓	✓	✓	✓	✓	✓	✓	✓	✓	✓	✓	✓
PC3054B	✓	✓	✓	✓	✓	✓	✓	✓	✓	✓	✓	✓
PC3030T	✓	✓	✓	✓	✓	✓	✓	✓	✓	✓	✓	✓
PC3036T	✓	✓	✓	✓	✓	✓	✓	✓	✓	✓	✓	✓
PC3040T	✓	✓	✓	✓	✓	✓	✓	✓	✓	✓	✓	✓



Model	Framed Cabinets								Frameless Cabinets			
	MBS	ES	MS	WS	MW	AW	GS	LGS	OW	AG	DG	RB
OVEN CABINET BASE & TOP (Width x 24" D x 84/90/94"H)												
OVD3072B	✓	x	x	x	x	x	x	x	✓	✓	✓	✓
OVD3012T	x	x	x	x	x	x	x	x	✓	✓	✓	✓
OVD3018T	x	x	x	x	x	x	x	x	✓	✓	✓	✓
OVD3022T	x	x	x	x	x	x	x	x	✓	✓	✓	✓
OVD3172B	✓	✓	✓	✓	✓	✓	✓	✓	x	x	x	x
OVD3112T	✓	✓	✓	✓	✓	✓	✓	✓	x	x	x	x
OVD3118T	✓	✓	✓	✓	✓	✓	✓	✓	x	x	x	x
OVD3122T	✓	✓	✓	✓	✓	✓	✓	✓	x	x	x	x



Model	Framed Cabinets								Frameless Cabinets			
	MBS	ES	MS	WS	MW	AW	GS	LGS	OW	AG	DG	RB
VANITY SINK BASE WITH DOUBLE DOOR (WIDTH x 21" D x 34 1/2"H)												
V2421	✓	✓	✓	✓	✓	✓	✓	✓	✓	✓	✓	✓
V3021	✓	✓	✓	✓	✓	✓	✓	✓	✓	✓	✓	✓
V3621	✓	✓	✓	✓	✓	✓	✓	✓	✓	✓	✓	✓

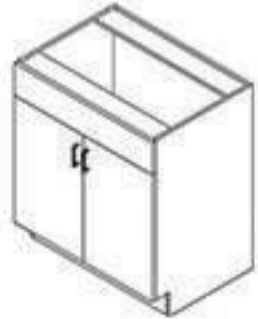

Model	Framed Cabinets								Frameless Cabinets			
	MBS	ES	MS	WS	MW	AW	GS	LGS	OW	AG	DG	RB
VANITY 3-DRAWERS BASE (WIDTH x 21" D x 34 1/2"H)												
VDB1221	✓	✓	✓	✓	✓	✓	✓	✓	✓	✓	✓	✓
VDB1521	✓	✓	✓	✓	✓	x	x	✓	x	x	x	x
VDB1821	✓	✓	✓	✓	✓	✓	✓	✓	✓	✓	✓	✓
VDB2421	✓	x	x	✓	x	x	x	x	x	x	x	x



Model	Framed Cabinets								Frameless Cabinets			
	MBS	ES	MS	WS	MW	AW	GS	LGS	OW	AG	DG	RB
VANITY SINK BASE WITH DRAWERS (WIDTH x 21" D x 34 1/2"H)												
V3021DLR	✓	✓	✓	✓	✓	✓	✓	✓	x	x	x	x
V3621DLR	✓	✓	✓	✓	✓	✓	✓	✓	x	x	x	x

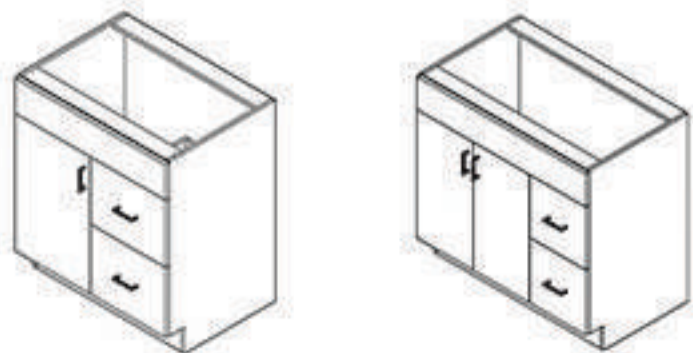









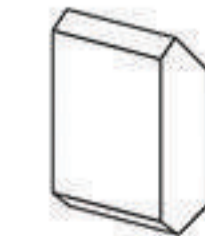

Model	Framed Cabinets								Frameless Cabinets			
	MBS	ES	MS	WS	MW	AW	GS	LGS	OW	AG	DG	RB
V4821DLR	✓	✓	✓	✓	✓	✓	✓	✓	x	x	x	x
V6021DLR	x	x	x	✓	x	x	x	x	x	x	x	x
V6021DC	x	x	x	✓	x	x	x	x	x	x	x	x

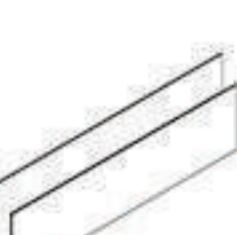

CABINET ACCESSORIES

Model	Descriptions	Framed Cabinets								Frameless Cabinets			
		MBS	ES	MS	WS	MW	AW	GS	LGS	OW	AG	DG	RB
WF330	Wall/Base Filler 3" x 30"	✓	✓	✓	✓	✓	✓	✓	✓	✓	✓	✓	✓
WF336	Wall Filler 3" x 36"	x	x	x	x	x	x	x	✓	✓	✓	✓	✓
WF340	Wall Filler 3" x 40"	✓	✓	✓	✓	✓	✓	✓	✓	✓	✓	✓	✓
WF640	Wall Filler 6" x 40"	✓	✓	✓	✓	✓	✓	✓	✓	✓	✓	✓	✓
TF1.5	Tall Filler 1 1/2" x 96"	x	✓	✓	✓	✓	✓	✓	x	x	x	x	x
TF296	Tall Filler 2" x 96"	x	x	x	x	x	x	x	✓	✓	✓	✓	✓
TF396	Tall Filler 3" x 96"	x	✓	✓	✓	✓	✓	✓	✓	✓	✓	✓	✓
TF696	Tall Filler 6" x 96"	x	x	x	✓	x	x	✓	x	x	x	x	x
BFD2430	Base Fake Door Panel 24" x 30"	✓	✓	✓	✓	✓	✓	✓	x	x	x	x	x
WFD1230	Wall Fake Door Panel 12" x 30"	✓	✓	✓	✓	✓	✓	✓	x	x	x	x	x
WFD1236	Wall Fake Door Panel 12" x 36"	✓	✓	✓	✓	✓	✓	✓	x	x	x	x	x
WFD1240	Wall Fake Door Panel 12" x 40"	✓	✓	✓	✓	✓	✓	✓	x	x	x	x	x
CM2-Curve	Crown Moulding Curve 2"	✓	✓	✓	✓	✓	✓	✓	x	x	x	x	x
CM4-Curve	Crown Moulding Curve 4"	✓	✓	✓	✓	✓	✓	✓	x	x	x	x	x
CM2-Flat	Crown Moulding Flat 3"	✓	✓	✓	✓	✓	x	✓	x	x	x	x	x
CM3-Flat	Crown Moulding Flat 3"	✓	✓	✓	✓	✓	x	✓	x	x	x	x	x

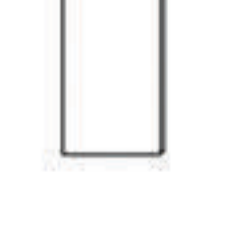

Model	Descriptions	Framed Cabinets								Frameless Cabinets			
		MBS	ES	MS	WS	MW	AW	GS	LGS	OW	AG	DG	RB
	LM8 Light Moulding 1 3/8" x 7/8" x 8"	✓	✓	✓	✓	✓	✓	✓	✓	×	×	×	×
	TK Toe Kick 4 1/2" x 1/2" x 8'	×	✓	✓	✓	✓	✓	✓	✓	✓	✓	✓	✓
	SM Scribe Moulding 3/4" x 1 1/8" x 8'	✓	✓	✓	✓	✓	✓	✓	✓	✓	✓	×	×
	OCM Outside Corner Moulding 3/4" x 3/4" x 8'	×	✓	✓	✓	✓	✓	✓	✓	✓	✓	×	×
	DWR Dishwasher Panel with 1.5 Filler	✓	✓	✓	✓	✓	✓	✓	✓	×	×	×	×
	BDP Base Decorative Panel 26 1/2" x 34.5" x 3/4"	×	×	×	×	×	×	×	×	✓	✓	✓	✓
	BIP Base Decorative Island Panel 26 1/2" x 34.5" x 3/4"	×	×	×	×	×	×	×	×	✓	✓	✓	✓
	RR96 Refrigerator Panel 24" x 96" x 1/2"	✓	✓	✓	✓	✓	✓	✓	✓	✓	✓	✓	✓
	FP24X96X1/8 Skin Panel 24" x 96" x 1/8"	×	✓	✓	✓	✓	✓	✓	✓	✓	✓	✓	✓
	FP34.5X96X1/8 Island Skin Panel 34.5" x 96" x 1/8"	✓	✓	✓	✓	✓	✓	✓	✓	✓	✓	✓	✓
	PNL34.5X96X5/8 Island Finish Panel Thick 96" x 34.5" x 5/8"	×	×	×	×	×	×	×	×	✓	✓	✓	✓
	WDP30 Wall Decorative Panel 12" x 30"	×	×	×	×	×	×	×	×	✓	✓	✓	✓
	WDP36 Wall Decorative Panel 12" x 36"	×	×	×	×	×	×	×	×	✓	✓	✓	✓
	WDP40 Wall Decorative Panel 12" x 40"	×	×	×	×	×	×	×	×	✓	✓	✓	✓
	WFP30 Wall Finish Panel 12" x 30"	×	×	×	×	×	×	×	×	✓	✓	✓	✓
	WFP36 Wall Finish Panel 12" x 36"	×	×	×	×	×	×	×	×	✓	✓	✓	✓
	WFP40 Wall Finish Panel 12" x 40"	×	×	×	×	×	×	×	×	✓	✓	✓	✓

Model	Descriptions	Framed Cabinets								Frameless Cabinets			
		MBS	ES	MS	WS	MW	AW	GS	LGS	OW	AG	DG	RB
	BTD15 / BTB15 Trash Can with Soft-Close Slide Single/ Double Can #BTD: Apply to Framed Cabinet	×	✓	✓	✓	✓	✓	✓	✓	✓	✓	✓	✓
	BTD18 / BTB18 B15/ B18/ B21 #BTB: Apply to Framed/ Frameless Cabinet B15/ B18	×	✓	✓	✓	✓	✓	✓	✓	✓	✓	✓	✓
	BTD21	×	✓	✓	✓	✓	✓	✓	✓	✓	✓	✓	✓
	LAZ33 Two Shelves Metal Wire Lazy Susan Set Apply to Cabinet BLS33/BLS36	×	✓	✓	✓	✓	✓	✓	✓	✓	✓	✓	✓
	LAZ36	×	✓	✓	✓	✓	✓	✓	✓	✓	✓	✓	✓
	BPP BOX Spicy Pull-Out Wood Shelf w/Soft-Close Slides Apply to Framed Cabinet B09F 4 7/8" x 25 5/8" x 19 1/2"	×	✓	✓	✓	✓	✓	✓	✓	×	×	×	×
	GR30 Wall Glass Rack Apply to Framed Cabinet WWR3015	×	✓	✓	✓	✓	✓	✓	✓	×	×	×	×
	PR3*34.5 Decorative Roman Post 3"x3"x34.5"H	×	✓	✓	✓	✓	✓	✓	✓	×	×	×	×
	PR6*34.5 Decorative Roman Post 6"x6"x34.5"H	×	✓	✓	✓	✓	✓	✓	✓	×	×	×	×
	ROT18 Roll Out Tray w/Soft-Close Slides Apply to 18"W~36"W Framed Cabinet	×	✓	✓	✓	✓	✓	✓	✓	×	×	×	×
	ROT21	×	✓	✓	✓	✓	✓	✓	✓	×	×	×	×
	ROT24	×	✓	✓	✓	✓	✓	✓	✓	×	×	×	×
	ROT27	×	✓	✓	✓	✓	✓	✓	✓	×	×	×	×
	ROT30	×	✓	✓	✓	✓	✓	✓	✓	×	×	×	×
	ROT33	×	✓	✓	✓	✓	✓	✓	✓	×	×	×	×
	ROT36	×	✓	✓	✓	✓	✓	✓	✓	×	×	×	×
	WB-B09TR Spicy Pull-Out Wood Shelf w/Soft-Close Slides Apply to Frameless Cabinet B09F 4 7/8" x 25 5/8" x 19 1/2"	×	×	×	×	×	×	×	×	✓	✓	✓	✓
	WB-ROT18 Roll Out Tray w/Soft-Close Slides Apply to 18"W~36"W Frameless Cabinet	×	×	×	×	×	×	×	×	✓	✓	✓	✓
	WB-ROT21	×	×	×	×	×	×	×	×	✓	✓	✓	✓
	WB-ROT24	×	×	×	×	×	×	×	×	✓	✓	✓	✓
	WB-ROT27	×	×	×	×	×	×	×	×	✓	✓	✓	✓
	WB-ROT30	×	×	×	×	×	×	×	×	✓	✓	✓	✓
	WB-ROT33	×	×	×	×	×	×	×	×	✓	✓	✓	✓
	WB-ROT36	×	×	×	×	×	×	×	×	✓	✓	✓	✓